

1 INTRODUCTION

The DELTA series of passive infrared detectors have been designed for installation in both domestic and industrial security systems. The range consists of:

D30 Volumetric Type PIR Coverage 15m x 85°
 D20 Volumetric Type PIR Coverage 12m x 85°
 D10 Curtain Type PIR Coverage 10m x 100°

2 PARTS DESCRIPTION

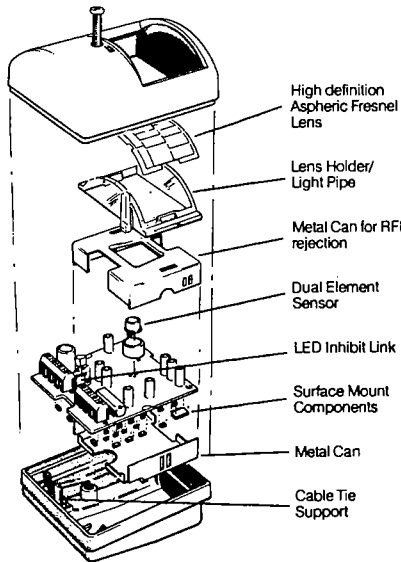

GENERAL DESCRIPTION

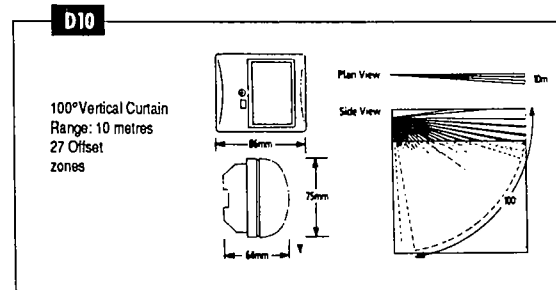
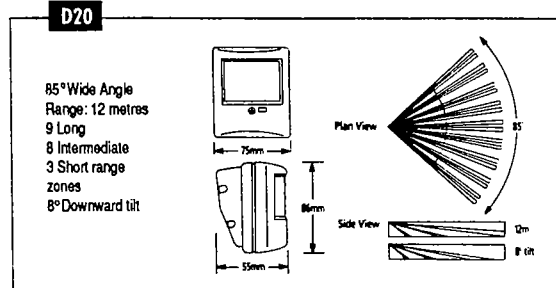
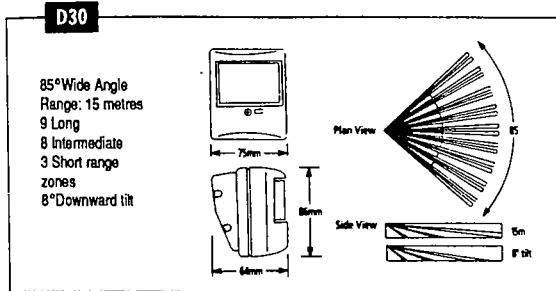

3 THE ALARM LATCH FUNCTION

The alarm latch is controlled by a +12v 'set' signal from the control panel. When the system is open, the LED lights whenever the unit is alarmed. Setting the system arms the latch and blanks the LED. If the unit is then alarmed, the latch trips and the LED will light continuously when the system is opened. The latch resets the next time the system is set. The alarm relay is not affected by the latch.

SPECIFICATION

Detection System	Passive Infrared, Lithium Tantalate Dual Element Sensor
Alarm Signal	Normally closed with 22 Ohm resistor in series Reset 1.5 seconds 30V DC, 75mA
Tamper Output	Normally Closed 30V DC 1 A max.
Supply Voltage	12V DC (9 to 16V), 10mA typ. at 12V DC
Latch Control Signal	9 to 16V DC, neg ground common to zero V supply
Ambient Temperature	-10°C to +40°C (14°F to 105°F)
Weight	125 grams (6 oz)
Case Material	White ABS with 2.5mm nominal wall thickness

4 THE WALK TEST LED

The walk test function of the LED can be disabled, without affecting its alarm latch indication, by removing the 'LED LK' jumper below the LED. Use a small pair of pliers and replace it on just one pin, away from the PCB fixing holes.

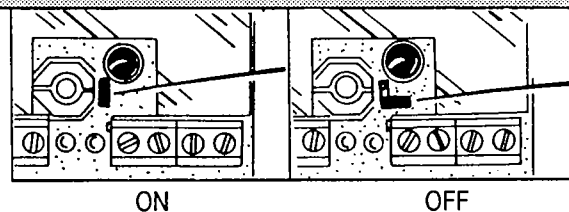

5 LOCATION TIPS

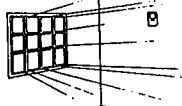
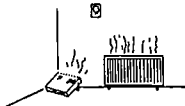

Avoid strong temperature changes, draughts, sunlight or car headlamps shining on unit.

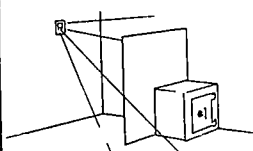
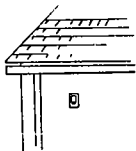

Do not install outdoors

Remember - PIR's cannot see through objects

6 FIXING

After removing bolt with Posidrive screwdriver, remove PCB module by releasing catch at top of unit.

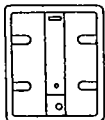
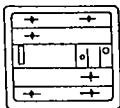
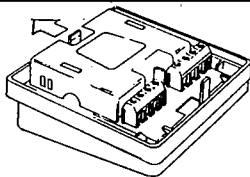

The D10 base is for wall or ceiling & wall mount. Note when mounting unit - terminal block should be on left hand side.

The D20/30 base has slots to ease siting adjustments.

Use the two screws provided to mount the unit. The wall plugs fit a 5mm hole.

7 ELECTRICAL

12V

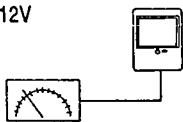

9V

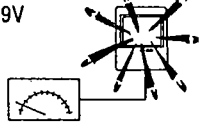

The detector requires a continuous nominal 12V DC supply. It will remain in alarm if supply drops below 9V.

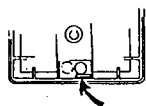
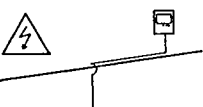

Avoid long cable runs to the unit alongside mains cables.

Secure the incoming cables to the LUG with the cable tie provided.

8 WIRING

Alarm Output NC
COM

Anti-Tamper A/T

Test Point TP

Supply +12V

OV

Latch SW12V

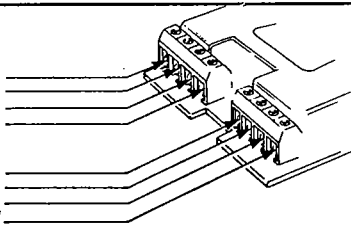

9 COMMISSIONING

When the cover and bolt have been replaced, connect the supply and wait for a minute to allow the unit to settle.

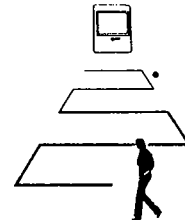
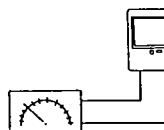

Background noise can be checked by connecting a voltmeter to the test point and OV terminals. The normal voltage is +2.5V and an alarm occurs on a 0.5V peak to peak change.

Walk test the unit checking all possible entrances.

10 TROUBLESHOOTING

SYMPTOM	POSSIBLE CAUSE	REMEDY
'DEAD' UNIT	Unit not yet warmed up.	Wait for warm up.
	Broken power cable. Wrong voltage.	Replace broken cable.
	Sensor masked.	Remove masking object.
LED NEVER LIGHTS	Led disable plug in 'Off' position.	Replace plug to 'On' position.
FALSE ALARMS	Improper power supply.	Correct power supply.
	Moving object or rapid temperature changes in protected area. Electrical noise from machinery.	Relocate unit to change protected area.
	Mains noise	Relocate wiring
LED LIGHTS BUT CONTROL PANEL DOES NOT ALARM.	Poor contact. Broken Cable. Insulation of signal line defective. Damaged alarm contact.	Check wiring.

securis

UNIT 6/7 CANBURY 2000
ELM CRESCENT, KINGSTON UPON THAMES,
SURREY KT2 6HJ ENGLAND
TEL: 01-541 4324

FAX: 01-547 1328 TELEX: 269649 VITEC G